

INSTALLATION GUIDELINE

VERLEGEANLEITUNG

RECOMMANDATION D'INSTALLATION

REGUFOAM vibration

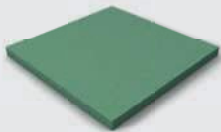

150plus



190plus



220plus

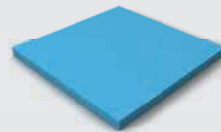

270plus

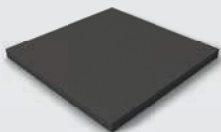

300plus

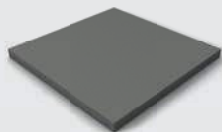

400plus

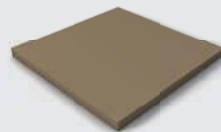

510plus



570plus

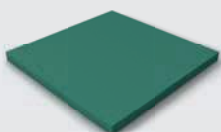

680plus



740plus

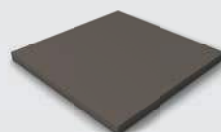

810plus

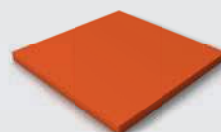

990plus

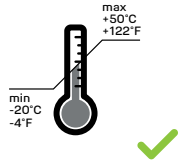

Keep dry & store inside

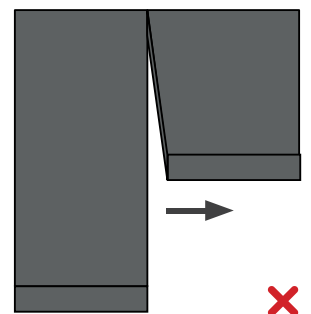
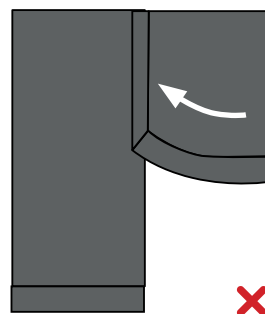
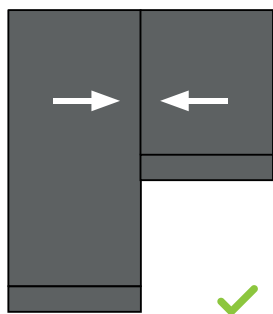
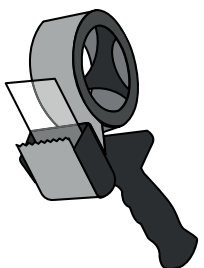
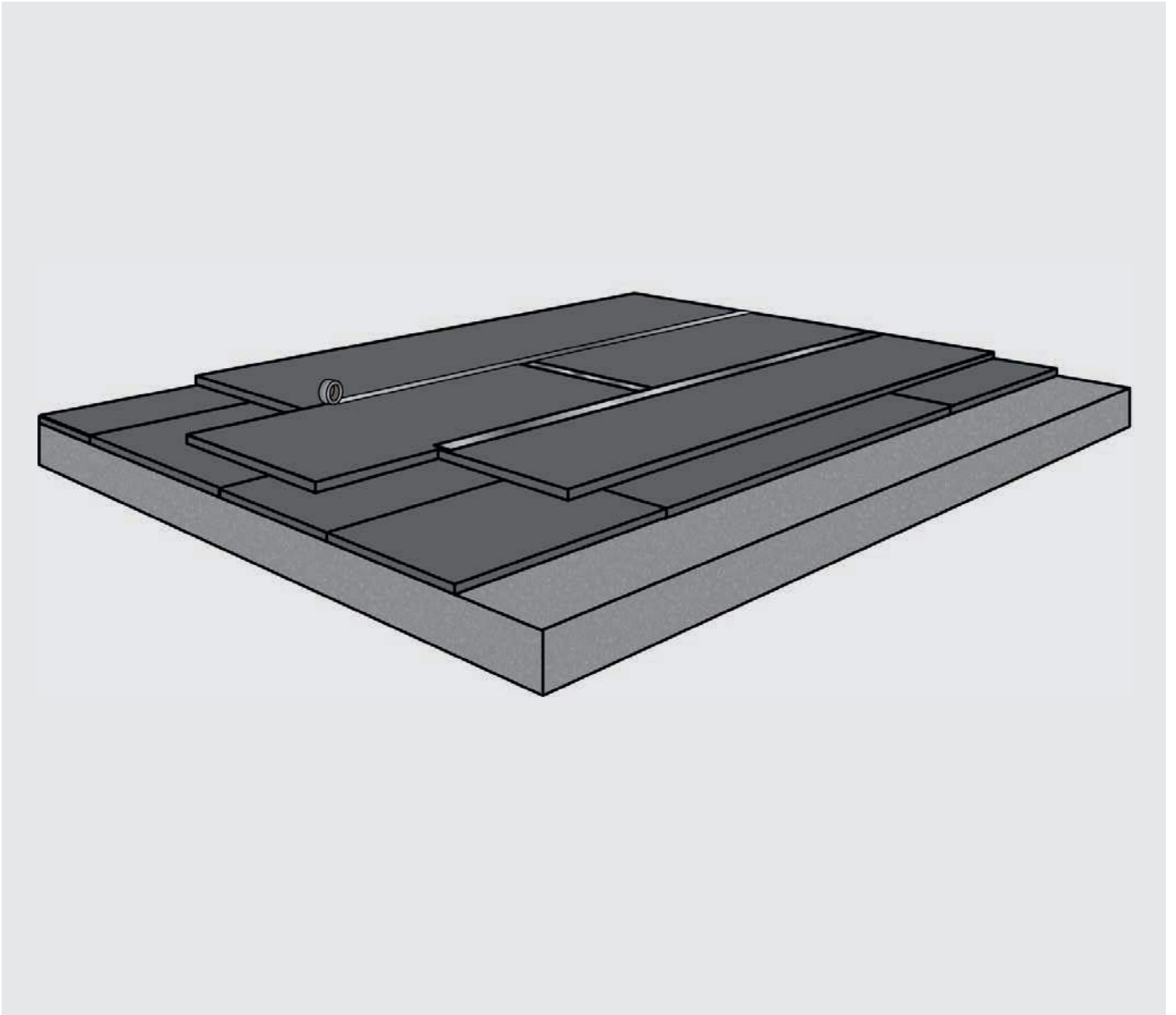

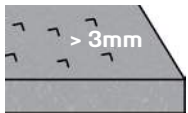

✗

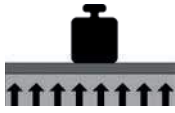

✓



✗

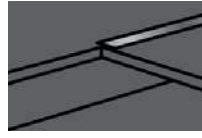

✓



✓



✗

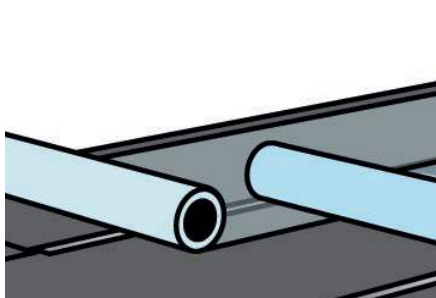
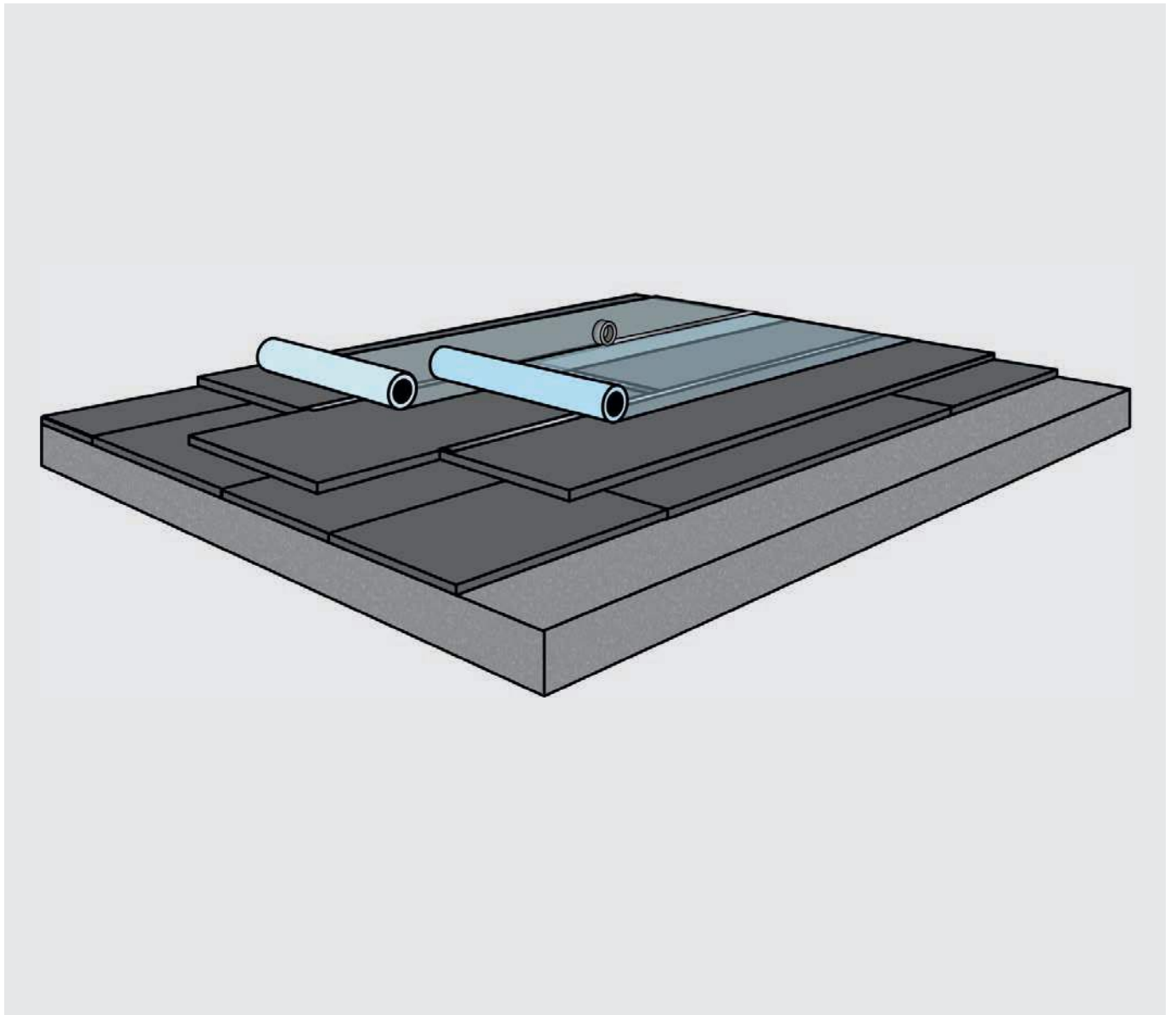

+

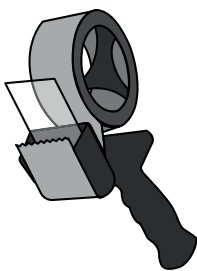

→

